

Øretermometer ST-103

Brugervejledning

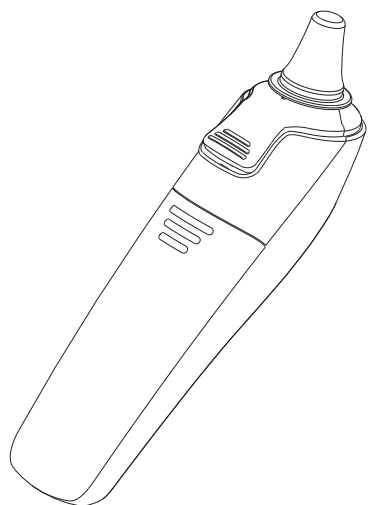

Læs venligst vejledningen grundigt før ibrugtagning – og gem den til senere brug.



Producent:
JOYTECH HEALTHCARE Co., Ltd.
No.365, Wuzhou Road, Yuhang Economic Development Zone,
Hangzhou city, 311100 Zhejiang, China
Telephone: +86-571-81957767
Fax: +86-571-81957750



Produktet er i overensstemmelse med kravene i MDD 93/42/EEC, og "0197" er nummeret på det godkendende bemyndigede organ



EU repræsentant
European Authorized Representative:
Shanghai International Holding Corp. GmbH (Europe)
Eiffestrasse 80, 20537 Hamburg, Germany

Importør:
Seagull Healthcare
Industrivej 1
4200 Slagelse
Denmark
+45 6171 5035
www.seagull-healthcare.dk

Indholdsfortegnelse

Produktintroduktion	02
Produktbeskrivelse	03
LCD display	04
Fordele ved temperaturmåling i øret	05
Normaltemperatur	06
Basisfunktioner	07
Indstillinger	08-09
Sådan bruges øretermometret	10
Sådan måles der på genstande	11
Vigtig viden	12
Hukommelse	13
Valg af måleenhed	14
Vedligeholdelse	15
Batteriskift	16
Specifikationer	17
Problemløsning	18-19
Symbolforklaring	20
Reklamationsret	21
Standarder	22
Elektromagnetisk kompatibilitet.....	23-29

Produktintroduktion

Seagull øretermometer ST-103 er designet til at måle i øregangen, præcist og sikkert. Det infrarøde øretermometer er et apparat, der er udviklet til at måle kropstemperatur ved hjælp af infrarødt lys, som reflekteres på trommehinden i øregangen hos mennesker. Derudover kan dette termometer måle temperaturen på genstande og væsker. Den målte temperatur kan aflæses på displayet. Du kan hurtigt se det præcise resultat.

Seagull øretermometer ST-103 kan bruges af alle, der ønsker en pålidelig måling – uanset alder.



Læs venligst nedenstående instruktioner grundigt inden ibrugtagningen af dette produkt.

Advarsel:

1. Dette termometer er kun beregnet til hjemmebrug. Det kan ikke erstatte et lægebesøg. Kontakt venligst egen læge hvis du har bekymringer om dit helbred.
2. Dette termometer kan anvendes af alle uanset køn og alder.
3. Brug altid en ny og ren ørehætte før hver måling. Dette sikrer en pålidelig måling.
4. Udsæt ikke termometret for ekstreme temperaturer (under $-25\text{ }^{\circ}\text{C}/-13\text{ }^{\circ}\text{F}$) ej heller ekstrem luftfugtighed ($>95\%\text{RH}$)
5. Dette termometer må kun bruges med Seagull ørehætter.
6. Hold batterierne væk fra børn.
7. Fjern batterierne hvis ikke termometret skal bruges i en længere periode.

Produktbeskrivelse

1. Engangs ørehætte
2. Proben
3. TEST knap
4. Tænd/Sluk knap
5. Batteridæksel

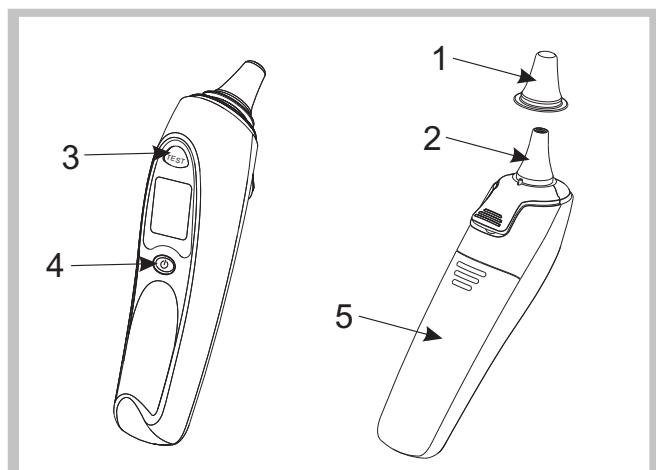

3

LCD display

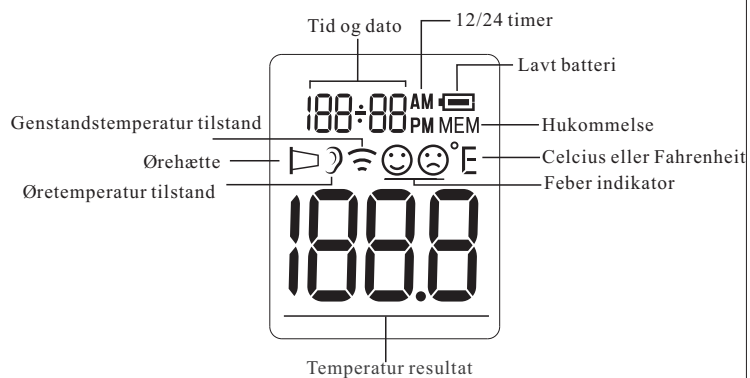

4

Fordele ved temperaturmåling i øret

Kliniske studier har vist, at øret er et godt sted til temperaturmåling, fordi temperaturer målt i øret afspejler kroppens kerntemperatur.

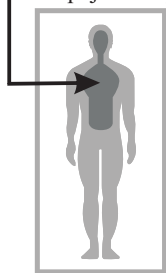

figur 1

Kerntemperaturen i kroppen er temperaturen i kroppens vigtige organer (se figur 1).

Temperaturen i øret er en præcis indikation for kerntemperaturen, da trommehinden er i kraniehulen og den derfor ikke påvirkes af udefrakommende temperaturændringer. Trommehinden deler blodforsyning med hypothalamus. Derfor vil en ændring af kropstemperaturen hurtigere kunne registreres her, end ved temperaturmåling andre steder på kroppen såsom endetarmen, munden eller i armhulen.

-Måling i armhulen giver kun en indikation af hudtemperaturen og ikke den indre temperatur

-Måling i endetarmen er ofte længere om at vise skift i temperaturen, især i perioder med hurtige temperaturskift

-Måling i munden er påvirket af indtagelse af mad og drikke, placering af termometeret, ind- og udånding gennem munden og om personen har holdt munden fuldstændig lukket under målingen.

5

Normaltemperatur

Det er meget vigtigt at du kender din normaltemperatur for at vurdere om du har feber. Derfor anbefaler vi, at alle måler deres temperatur, mens de er raske.

Normaltemperatur varierer fra person til person og påvirkes af mange faktorer så som tidspunkt på dagen, aktivitetsniveau, medicin, køn og alder.

Temperaturen er ikke den samme, når der måles rektalt, i øret og/eller på panden. Der kan også være forskel på højre og venstre øre ved måling med et øretermometer. Alle de nævnte steder påvirkes af kroppens temperaturfald og -stigning. Derfor kan temperaturen måles korrekt de nævnte steder, men ikke sammenlignes.

Det er derfor vigtigt at du anvender samme type termometer og målested hver gang der måles.

Når du kender din normaltemperatur, kan du oplyse denne og den målte temperatur. Så kender lægen temperaturændringen og har derfor et godt grundlag for at vurdere din aktuelle tilstand.

6

Basisfunktioner

Ur	Uret bruges i hukommelsesfunktionen og kan få hjælpe dig til at holde styr på tidligere målinger. Læs gerne punkt 8 Indstillinger (Side 8) → hvor du kan hjælp til korrekt indstilling
Øretermometer funktion	Dette termometer er udviklet til at måle temperatur i øret. Målingen kan ikke erstatte et lægebesøg. Det er vigtigt at måleresultatet sammenlignes med kroppens normaltemperatur. Se venligst illustrationen på Figur. 1. Læs venligst emnet om indstillinger side 8-10
Engangs ørehætte og eject funktion	Dette termometer er beregnet til at benytte en ny ørehætte til hver eneste måling. Når ørehætten skal fjernes, gøres dette nemmest ved at trykke på eject-knappen
Genstandsmåling	Ved en genstandsmåling måles den aktuelle temperatur på overfladen af genstanden, denne måling er forskellig fra en måling i øret. Med denne måling kan resultatet komme brugeren til gode, f.eks. ved måling på en sutteflaske Læs venligst emnet om indstillinger side 11
Alarm	Hvis termometeret måler en temperatur >/- 37,8 °C (100,0 °F) ved en måling i øret, vil der lyde en lang bip lyd efterfulgt af 3 korte bip lyde, dette for at gøre brugeren opmærksom på resultatet
Hukommelse	Dette termometer har hukommelse på hhv. 10 målinger for øremåling og genstandsmåling. For hver gemt måling kan tid og dato aflæses
Skift mellem °C/°F	Læs venligst afsnittet om Valg af måleenhed på side 14. Her finder du en beskrivelse af, hvordan der skiftes mellem Celcius og Fahrenheit

7

Indstillinger dato og tid

Når termometeret skal bruges for første gang, skal det indstilles efter denne anvisning. Når termometeret er slukket, holdes  Tænd/sluk nede i 3 sek, herefter kan det indstilles.



① Indstil tidsformat

Termometeret kan anvendes med 12 timers format (AM/PM) og med 24 timers format.

Tryk på TESTknappen for at skifte mellem 12 eller 24 timer. Tryk og slip tænd/sluk knappen for at vælge det ønskede.



② Indstilling af timerne

Tryk og slip TESTknappen, tryk indtil du har den rigtige time. Tryk derefter på tænd/sluk knappen for at gemme.



③ Indstilling af minutterne

Tryk og slip TESTknappen indtil du har det rigtige minuttal. Tryk derefter på tænd/sluk knappen for at gemme.

8

Indstillinger dato og tid



④ Indstilling af årstal

Tryk og slip TESTknappen til det rigtige årstal står i displayet. Tryk derefter på tænd/sluk knappen for at gemme.



⑤ Indstilling af måned

Tryk og slip TESTknappen indtil den aktuelle måned vises i displayet. Tryk derefter på tænd/sluk knappen for at gemme.



⑥ Indstilling af dato

Tryk og slip TESTknappen indtil den aktuelle dato vises i displayet. Tryk derefter på tænd/sluk knappen for at gemme.

9

Sådan bruges øretermometeret

En ny og ren ørehætte påsættes proben før hver eneste måling.

Sørg for at sætte hæften korrekt på.

Vær opmærksom på at termometeret kun kan måle, hvis der er sat en ørehætte på. Se Figur 3. Hvis der står CAP i displayet betyder det, at der mangler at blive påsat en hætte eller at hæften ikke sidder korrekt.

1. Tryk på Tænd/Sluk knappen. Samtlige symboler vil nu fremkomme i displayet. Apparatet er indstillet til at tjekke funktionerne, inden der foretages en måling. Se Figur 2, sådan vil displayet nu se ud og der vil lyde et bip. Der kan nu foretages en måling. Hvis der fremkommer en Error fejlmeddelelse, kan der ikke måles.



Figur 2



Figur 3

2. Indfør proben på termometeret i øregangen. proben skal sidde tæt i øregangen. Tryk på TESTknappen for at foretage en måling.

Efter 1 sek vil der lyde en langt BIP og resultatet kan aflæses på displayet.

3. Termometeret er klar til en ny måling, når øre ikonet ses i displayet. Vi anbefaler dog mindst 20 sek. mellem hver måling og minder om, at der skal påsættes en ny ørehætte.

4. Termometeret slukker automatisk efter 60 sek. For at forlænge batteriets levetid kan du slukke det efter brug. Termometeret slukkes ved at trykke på  tænd/sluk knappen.

10

Sådan måles der på genstande

1. Tryk på TÆND/SLUK knappen og fjern herefter engangs ørehætten.
2. Termometret skal stå i genstandsmode. Det gøres ved at trykke og holde TÆND/SLUK knappen nede samtidig med at du trykker og holder TEST knappen nede, herefter kan du skifte mellem øre- og genstandsmåling.
3. Termometret er klar til en genstandsmåling når du har hørt 2 BIP lyde og displayet ser ud som vist på Figur 5
4. Placer termometret 1-2 cm fra midten af genstanden, du ønsker at måle på.

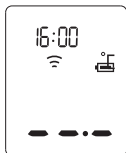

Figur 5

Efter måling:

1. Apparatet vil slukke automatisk efter 60 sek. For at forlænge batteriets levetid kan du slukke det efter brug. Termometret slukkes ved at trykke på tænd/sluk knappen.

Baggrundslys:

Øremåling:

1. Displayet vil lyse grønt og vise en glad smiley i 3 sek., når apparatet er klar til at foretage en måling samt efter en måling med et resultat lavere end 37.3°C (99.1°F)
2. Displayet vil lyse gult og vise en glad smiley i 3 sek., når målingen er gennemført med et resultat under 37.8°C (100.0°F)
3. Displayet vil lyse rødt og vise en sur smiley i 3 sek. når målingen er gennemført med et resultat på eller højere end 37.8°C (100.0°F)

Genstandsmåling:

Displayet vil lyse grønt i 3 sek. når apparatet er klar til at foretage en måling, samt når målingen er gennemført.

11

Vigtig viden

1. Der kan være forskel på resultatet hvis du måler i højre eller venstre øre. Vi anbefaler derfor, at du altid måler i det samme øre.
2. Øregangen skal være ren og tør, inden der foretages en måling. Ørevoks, puds mm kan være medvirkende årsager til et forkert resultat.
3. Udefrakommende faktorer kan påvirke resultatet så som:
 - Hvis du lige har ligget på øret
 - Hvis du har været ude i ekstremt varmt eller koldt vejr
 - Hvis du lige har svømmet eller været i badI ovenstående tilfælde bedes du vente 20 min., inden der foretages en temperaturmåling.
4. Hvis du bruger høretelefoner eller ørepropper, skal du fjerne disse og vente 20 min., inden der foretages en temperaturmåling.
5. Hvis der skal måles på et barn under 1 år, bedes du sikre at ørekanalen er rettet ud. Dette sikres ved at lave et let træk i øret opad. Se figur 6.
6. Hvis der skal måles på personer over 1 år, bedes du sikre at ørekanalen er rettet ud. Dette sikres ved at lave et let træk i øret bagud. Se figur 7.
7. Rør ikke ved linsen på proben. Den kan rengøres med en vatrondel påført lidt sprit (må ikke indeholde glycerin).
8. Hvis termometret har været udsat for betydelige temperaturændringer bedes det opbevaret under almindelige forhold i mindst 20 min., før der foretages en måling.



Figur 6



Figur 7

12

Hukommelse

1. Hukommelsen kan tilgås for enten øre- eller genstandsmålingerne. Tænd termometret og vælg enten øre eller genstandssikonet – se figur 2 og figur 5. Hukommelsen kan også tilgås efter endt måling. Termometret skal være tændt. Tryk og hold TÆND/SLUK knappen nede i 3 sek. Der vil nu komme MEM frem i displayet i højre hjørne. Se figur 8.
2. Termometret vil automatisk have lagret de seneste 10 målinger i hukommelsen. For at bladre i hukommelsen trykkes TÆND/SLUK knappen ned og slippes igen. Hver gemt måling har et nummer fra 1-10. Nummer 1 er den seneste måling og nummer 10 er den ældste måling. Der kan også aflæses dato og klokkeslæt for hver gemt måling. Se Figur 9.
3. I hukommelsen vil der altid være et ikon for øremåling eller genstandsmåling. Brugeren kan trykke på TEST knappen for at foretage en ny måling.

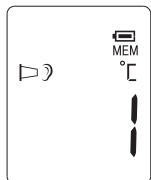

Figur 8

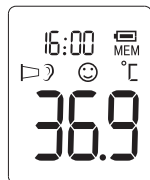

Figur 9

13

Valg af måleenhed

1. Der kan aflæses i enten Celcius (°C) eller Fahrenheit (°F) skalaen.
2. Tryk TEST knappen nede i 3 sek. når termometret er slukket. Herefter kan du vælge mellem Celcius og Fahrenheit.
3. Tryk og slip TEST knappen for at vælge skala.
4. Når den foretrukne skala ses i displayet trykkes der på TÆND/SLUK knappen for at komme ud af denne indstilling.

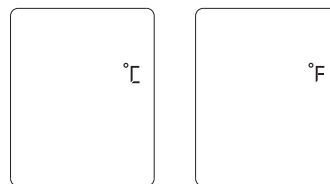

Figur 10

14

Vedligeholdelse

1. Engangs ørehætten er kun beregnet til engangsbrug. Ødelagte og/eller perforerede hætter kan forårsage ukorrekte måleresultater.
2. Linsen på proben skal være ren og tør for at sikre korrekte målinger. Der kan fremkomme fejlagtige målinger, hvis linsen på proben er itu eller beskidt af ørevoks.
3. Fingeraftryk, ørevoks og støv kan mindske det infrarøde lys gennembrængelighed på hætten og resulterer i lavere måleresultater.
4. Linsen på proben er den mest følsomme del af dette termometer. Rengør linsen med en vatrundel eller andet blødt og fnugfrit materiale fugtet med 75% isopropyl alkohol. Tør straks efter med en tør blød klud. Efter rengøring anbefaler vi at vente 5 minutter, inden der foretages en måling.
5. Brug en tør blød klud til at rengøre display og håndtag.
6. Termometret er IKKE vandfast. Hold derfor aldrig dette termometer under en rindende vandhane.
7. Opbevar termometret i tørre omgivelser, væk fra støv og direkte sollys.
8. Lejlighedsvis rengøring og desinfektion af apparatet vil nedsætte risikoen for krydskontaminering. Brug en blød klud fugtet med 75% isopropyl alkohol til desinfektion af apparatet.
9. Sikr dig at mindre børn ikke kan komme til apparatet uden opsyn: det indeholder dele som er så små, at de kan sluges.
10. Termometret må ikke modificeres uden tilladelse.
11. Skal holdes væk fra stærke magnetiske felter da dette ellers kan påvirke termometret.
12. Opbevar termometret i etuiet når det ikke er i brug.
13. Termometret er ikke beregnet til at blive brugt i oxygenholdige omgivelser og det er brandfarligt i kombinationen af ilt, oxygen og nitrogen.

15

Batteriskift

1. Skift batteriet når  kommer frem i øverste højre hjørne i displayet som set på figur 11.
2. Skub batteridækslet nedad – som vist på figur 12.
3. Fjern de brugte batterier og installer 2 nye AAA alkaline batterier som vist på figur 13.
4. Skub batteridækslet tilbage så det er lukket.



Figur 11

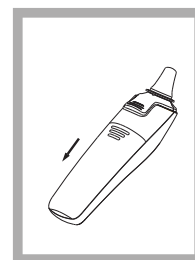

Figur 12

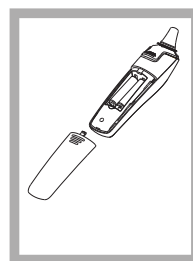

Figur 13





16

Specifikationer

Måleområde	I øret: 32-43 °C (89,6-109,4°F) På genstande: 0-100 °C (32-212°F)
Præcision	+/- 0,2 °C (0,4°F) i intervallet 35,5-42,0°C (95,9-107,6°F) +/- 0,3°C (0,5°F) ved måletemperatur 16-35°C (60,8-95°F) og over 42,0°C (107,6°F)
Antal decimaler på resultat	1
Måletid	Ca 1 sekund
Måletemperatur	10-40°C (50-104°F) ~85% luftfugtighed
Opbevaringstemperatur	-25-55°C (-13-131°F) ~95% luftfugtighed
Gentagelsesnøjagtighed	+/-0,13°C (0,23°F)
Holdbarhed ved tab	Termometret kan holde til at blive tabt 1 meter
Størrelse	15,5 x 3,8 x 4,7 cm
Vægt	Ca 83 gram med batterier
Batteri	2 stk AAA-batterier
Batterilevetid	Ca 6000 målinger
Fugt	Apparatet tåler aftørring med fugtig klud







17

Problemløsning

Skærm	Problem	Løsning
	Måling før klarsignal	Vent med at tage en temperaturmåling indtil (ear temperature icon) eller (object temperature icon) vises i displayet.
	Måletemperaturen er udenfor intervallet	Læg øretermometeret i stuetemperatur i mindst 20 minutter. Se måletemperatur i Specifikationer
	Øretermometeret holdes forkert eller rystes	Læs: Sådan bruges øretermometeret grundigt og gentag målingen. (side 10)
	Øretermometeret er i svingende rumtemperaturer	Placer øretermometeret ved stuetemperatur i mindst 20 minutter. Se måletemperatur i Specifikationer
	Systemet fungerer ikke korrekt	Tag batterierne ud og vent et minut. Isæt herefter batterierne. Hvis denne fejl stadig vises, kontaktes købsstedet eller importøren





18

Problemløsning

Skærm	Problem	Løsning
	Termometret er indstillet til genstandsmåling, men der er en ørehætte på proben	Fjern ørehætten når termometret skal bruges til en genstandsmåling
	Den målte øretemperatur er over 43°C (109,4°F) Den målte genstandstemperatur er over 100 °C (212 °F)	Læs: Sådan bruges øretermometret. (Side 10) Tjek ørehætten og gentag målingen
	Den målte øretemperatur er under 32°C (89,6°F) Den målte genstandstemperatur er under 0°C (32°F)	Læs: Sådan bruges øretermometret. (Side 10) Tjek ørehætten og gentag målingen
	Højt batteriniveau	Termometret kan bruges normalt
	Der skal snart skiftes batteri, men du kan fortsat bruge termometret	Termometret tager fortsat korrekte målinger, men batterierne skal snart skiftes
	Lavt batteriniveau	Udskift batterierne med 2 nye AAA batterier
	Der skal påsættes en ørehætte inden der kan foretages en måling	HUSK der skal altid benyttes en ny og ren ørehætte før hver øremåling

19

Symbolforklaring

	Udstyr til anvendelse på mennesker
	Bortskaffelse af produktet og brugte batterier skal ske i overensstemmelse med de nationale retningslinjer for bortskaffelse
	Følg den vedlagte brugsanvisning
	Batch nummer
	Opbevaringstemperatur og transporttemperatur – angivet som grænser

20

Reklamationsret

Seagull Healthcare tilbyder 2 års reklamationsret fra købsdatoen. Følgende dækkes ikke:

1. Hvis produktet har været adskilt
2. Hvis produktet har været behandlet hårdhændet under brug eller transport.
3. Hvis produktet er benyttet på anden vis, end beskrevet her i anvisningen. Herunder har været anvendt uden hætte, så der sidder ørevoks på linsen.

Kontakt den forhandler hvor produktet er købt eller Seagull Healthcare direkte. Der ydes kun garanti hvis hele produktet returneres sammen med original faktura udstedt af forhandleren.

21

Gældende standarder

Anvendte standarder: EN12470-5:2003 Clinical thermometers – Part 5: Performance of infrared ear thermometers (med maximum device.)

ISO 80601-2-56 Medicinsk elektrisk udstyr —Part 2-56: Særlige krav til sikkerhed og vigtige funktioner i digitale termometre til kropstemperaturmåling, IEC 60601-1-11 Medicinsk elektrisk udstyr – Part 1-11: Sikkerhed

Standard: Krav til medicinsk elektrisk udstyr og medicinske elektriske systemer, der bruges i hjemmet og opfylder ligeledes kravene i IEC/EN 60601-1-2 (EMC), og IEC/EN 60601-1-2 (sikkerhed) standarder.

Producenten er ISO 13485 certificeret.

22

Elektromagnetisk kompatibilitet

Tabel 1

Vejledning og producentens erklæring for elektromagnetisk emission		
Termometret er beregnet til brug i elektromagnetiske omgivelser som specificeret nedenfor. Brugeren af termometret skal sikre sig, at det bliver benyttet i de korrekte omgivelser		
Emissionstest	Overensstemmelse	Elektromagnetiske omgivelser vejledning
RF-emission CISPR 11	Gruppe 1	Enheden anvender kun HF energi til interne funktioner. Derfor er dens HF-emission meget lav og forventes ikke at forårsage interferens i elektronisk udstyr i nærheden
RF-emission CISPR 11	Klasse B	Termometret kan anvendes på alle behandlingssteder inkl. private og de, som er direkte tilsluttet til det offentlige lavspændingsnet
Harmonisk emission IEC 61000-3-2	Overholdes	
Spændingsudsving/Flimmer emission IEC 61000-3-3	Overholdes	

23

Elektromagnetisk kompatibilitet

Tabel 2

Vejledning og producentens erklæring – elektromagnetisk immunitet			
Termometret er beregnet til brug i elektromagnetiske omgivelser som specificeret nedenfor. Brugeren af termometret skal sikre sig, at det bliver benyttet i de korrekte omgivelser			
Immunitetstest	IEC 60601 test niveau	Overensstemmelsesniveau	Elektromagnetiske omgivelser - vejledning
Elektrostatisk afladning (ESD) IEC 61000-4-2	± 8 kV kontakt ± 2 kV, ± 4 kV, ± 8 kV, ± 15 kV luft	± 8 kV kontakt ± 2 kV, ± 4 kV, ± 8 kV, ± 15 kV luft	Gulv skal være træ, beton eller keramisk. Hvis gulvet er af syntetisk materiale, bør den relative luftfugtighed være (=) mindst 30%
Elektrostatisk transient/byge-transienter IEC61000-4-4	±2 kV I strømforsyningsledning ± 1 kV I input/output ledninger	± 2 kV I strømforsyningsledning ± 1 kV I input/output ledninger	Den generelle strøm kvalitet bør være den type, som benyttes kommercielt eller på hospitalet
Overspændings-immunitet IEC61000-4-5	± 0,5 kV i differentiale mode ± 1 kV i almindelig mode	± 0,5 kV i differentiale mode ± 1 kV i almindelig mode	
Spændingsdyk, korte spændingsudfald og variationer I forsynings-spændingen IEC61000-4-11	0% UT; 0,5 periode UT At 0°, 45°, 90°, 135°, 180°, 225°, 270° and 315° 0% UT ; periode og 70% UT ; 25/30 perioder Enkelt-Fase: ved 0° 0% UT ; 250/300 periode	0% UT; 0,5 periode UT At 0°, 45°, 90°, 135°, 180°, 225°, 270° and 315° 0% UT ; periode og 70% UT ; 25/30 perioder Enkelt-Fase: ved 0° 0% UT ; 250/300 periode	Den generelle strøm kvalitet bør være den type, som benyttes kommercielt eller på hospitalet Hvis termometret skal benyttes ved strømafrydelse, skal der benyttes batteri som strømkilde
Strømfrekvens-magnetiske felter (50/60 Hz) IEC61000-4-8	30 A/m	30 A/m	Strømfrekvens-magnetiske felter skal være på niveau med den type, som benyttes kommercielt eller på hospitalet

Note: UT er AC-netspænding for anvendelse af testniveauet

24

Elektromagnetisk kompatibilitet

Tabel 3

Vejledning og producentens erklæring – elektromagnetisk immunitet			
Termometret er beregnet til brug i elektromagnetiske omgivelser som specificeret nedenfor. Brugeren af termometret skal sikre sig, at det bliver benyttet i de korrekte omgivelser			
Immunitetstest	IEC 60601 test niveau	Overensstemmelsesniveau	Elektromagnetiske omgivelser - vejledning
Gennemført HF IEC 61000-4-6	3 Vrms 150 kHz til 80 MHz 6 V i ISM og amatørradiobånd mellem 0,15 MHz og 80 MHz	3 V 150 kHz til 80 MHz 6 V i ISM og amatørradiobånd mellem 0,15 MHz og 80 MHz	Bærbart og mobilt RF kommunikationsudstyr bør ikke anvendes tættere på denne enhed (inklusive kabler) end den anbefalede separationsafstand beregnes i forhold til frekvensen på senderen $d = \left[\frac{3,5}{V_1} \right] \sqrt{P}$ $d = \left[\frac{3,5}{E_1} \right] \sqrt{P}$ 80MHz to 800MHz $d = \left[\frac{7}{E_1} \right] \sqrt{P}$ 800MHz to 2.7GHz
HF stråling IEC 61000-4-3	10 V/m 80 MHz til 2,7 GHz	10 V/m 80 MHz til 2,7 GHz	Hvor P er max udgangseffekt på sender I watt(W) ifølge senderproducenten og d er den anbefalede separationsafstand I meter (m) Feltstyrker fra faste HF -sendere fastsat i en elektromagnetisk pladsoversigt skal være mindre end overensstemmelsesniveauet i hvert frekvensområde Interferens kan forekomme i nærheden af udstyr mærket med følgende symbol: 

25

Elektromagnetisk kompatibilitet

Note 1. Ved 80 MHz og 800 MHz er det højeste frekvensområde gældende
Note 2. Disse retningslinjer er evt. ikke gældende i alle situationer. Elektromagnetisk udbredelse påvirkes af absorption og refleksion fra strukturer, objekter og mennesker

- a. ISM-bånd mellem 150 kHz og 80 MHz er 6,765 MHz til 6,795 MHz; 13,553 MHz til 13,567 MHz; 26,957 MHz til 27,283 MHz; og 40,66 MHz til 40,70 MHz. Amatørradio bånd mellem 0,15 MHz og 80 MHz er 1,8 MHz til 2,0 MHz, 3,5 MHz til 4,0 MHz, 5,3 MHz til 5,4 MHz, 7 MHz til 7,3 MHz, 10,1 MHz til 10,15 MHz, 14 MHz til 14,2 MHz, 18,07 MHz til 18,17 MHz, 21,0 MHz til 21,4 MHz, 24,89 MHz til 24,99 MHz, 28,0 MHz til 29,7 MHz og 50,0 MHz til 54,0 MHz
- b. Feltstyrker fra faste sendere kan ikke med nøjagtighed forudsiges teoretisk. For at vurdere de elektromagnetiske omgivelser i forbindelse med HF -sendere skal en elektromagnetisk pladsoversigt udarbejdes. Hvis den målte feltstyrke på det sted, hvor enheden skal anvendes, overstiger det gældende HF -overensstemmelsesniveau ovenfor skal enheden observeres for normal drift. Hvis der konstateres unormal drift, kan yderligere foranstaltninger være nødvendigt, så som at dreje eller flytte enheden.
- c. I frekvensområdet 150 kHz til 80 MHz skal feltstyrker være mindre end 3 V/m

26

Elektromagnetisk kompatibilitet

Tabel 4

Anbefalede separationsafstande mellem bærbart og mobilt HF kommunikationsudstyr og apparatet			
Termometret er beregnet til anvendelse i elektromagnetiske omgivelser, hvor emissions HF -forstyrrelser er kontrollerede. Kunden eller brugeren kan forhindre elektromagnetisk inferens ved at holde en mindste afstand mellem bærbart og mobilt HF kommunikationsudstyr og termometret, som anbefalet nedenfor i henhold til den maksimale udgangseffekt på kommunikationsudstyret			
Max mærkeeffekt udgang på sender 1 W	Separationsafstand iht. frekvens på sender (1 meter)		
	150 kHz til 80 MHz $d = \left[\frac{3.5}{V_1}\right]\sqrt{P}$	80 MHz til 800 MHz $d = \left[\frac{3.5}{E_1}\right]\sqrt{P}$	800 MHz til 2,7 GHz $d = \left[\frac{7}{E_1}\right]\sqrt{P}$
0.01	0.12	0.04	0.07
0.1	0.37	0.12	0.23
1	1.17	0.35	0.7
10	3.7	1.11	2.22
100	11.7	3.5	7.0
For sendere med en max. effekt på udgang, som ikke er nævnt ovenfor, kan den anbefalede separationsafstand i meter (m) beregnes med ligningen, som er gældende for frekvensen på senderen, hvor P er den maksimale udgangseffekt på senderen i watt (W) i henhold til producenten Note 1: Ved 80 MHz og 800 MHz er separationsafstanden for det højeste frekvensområde gældende Note 2: Disse retningslinjer er ikke gældende i alle situationer. Elektromagnetisk udbredelse påvirkes af absorption og refleksion fra strukturer, ting og mennesker			

Elektromagnetisk kompatibilitet

Tabel 5

Anbefalede separationsafstande mellem bærbart og mobilt HF kommunikationsudstyr og apparatet			
Termometret er beregnet til anvendelse i elektromagnetiske omgivelser, hvor emissions HF -forstyrrelser er kontrollerede. Kunden eller brugeren kan forhindre elektromagnetisk inferens ved at holde en mindste afstand mellem bærbart og mobilt HF kommunikationsudstyr og termometret, som anbefalet nedenfor i henhold til den maksimale udgangseffekt på kommunikationsudstyret			
Max mærkeeffekt udgang på sender 1 W	Separationsafstand iht. frekvens på sender (1 meter)		
	150 kHz til 80 MHz $d = \left[\frac{3.5}{V_1}\right]\sqrt{P}$	80 MHz til 800 MHz $d = \left[\frac{3.5}{E_1}\right]\sqrt{P}$	800 MHz til 2,7 GHz $d = \left[\frac{7}{E_1}\right]\sqrt{P}$
0.01	0.12	0.04	0.07
0.1	0.37	0.12	0.23
1	1.17	0.35	0.7
10	3.7	1.11	2.22
100	11.7	3.5	7.0
For sendere med en max. effekt på udgang, som ikke er nævnt ovenfor, kan den anbefalede separationsafstand i meter (m) beregnes med ligningen, som er gældende for frekvensen på senderen, hvor P er den maksimale udgangseffekt på senderen i watt (W) i henhold til producenten Note 1: Ved 80 MHz og 800 MHz er separationsafstanden for det højeste frekvensområde gældende Note 2: Disse retningslinjer er ikke gældende i alle situationer. Elektromagnetisk udbredelse påvirkes af absorption og refleksion fra strukturer, ting og mennesker			

Elektromagnetisk kompatibilitet

Tabel 4

Anbefalede separationsafstande mellem HF mobilt kommunikationsudstyr					
Termometret er beregnet til anvendelse i elektromagnetiske omgivelser, hvor emissions HF -forstyrrelser er kontrollerede. Kunden eller brugeren kan forhindre elektromagnetisk inferens ved at holde en mindste afstand mellem mobilt HF kommunikationsudstyr og termometret, som anbefalet nedenfor i henhold til den maksimale udgangseffekt på kommunikationsudstyret					
Frekvens MHz	Maksimal effekt W	Distance	IEC 60601 Test Niveau	Compliance niveau	Elektromagnetisk omgivelser - vejledning
385	1.8	0.3	27	27	Mobilt RF kommunikationsudstyr bør ikke anvendes tættere på denne enhed (inklusive kabler) end den anbefalede separationsafstand beregnes i forhold til frekvensen på senderen Anbefalet separationsafstand $E = \frac{6}{d} \sqrt{P}$ Hvor P er max udgangseffekt på sender i watt(W) ifølge senderproducenten og d er den anbefalede separationsafstand i meter(m) Feltstyrker fra faste HF -sendere fastsat i en elektromagnetisk pladsoversigt skal være mindre end overensstemmelsesniveauet i hvert frekvensområde Interferens kan forekomme i nærheden af udstyr mærket med følgende symbol: <div style="text-align: center;">  </div>
450	2	0.3	28	28	
710	0.2	0.3	9	9	
745					
780					
810	2	0.3	28	28	
870					
930					
1720					
1845	2	0.3	28	28	
1970					
2450	2	0.3	28	28	
5240	0.2	0.3	9	9	
5500					
5785					
Note 1: Disse retningslinjer er evt. ikke gældende i alle situationer. Elektromagnetisk udbredelse påvirkes af absorption og refleksion fra strukturer, ting og mennesker					

Owner's Manual

Infrared Ear Thermometer

Model ST-103(DET-103)

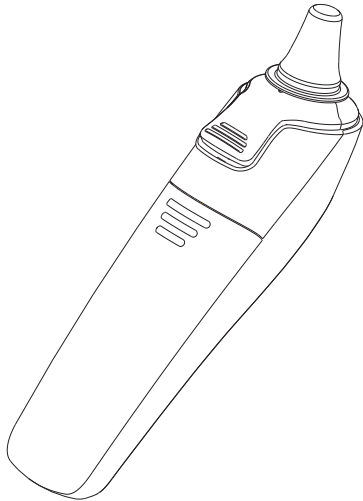

Document No.: JDET-0304-005
Article No.: 007
Version: Z
Date of Issue: 2023.05

Contents

Introduction	02
Product Description	03
Lcd Display Introduction	04
Basic Functions	05
Ear Thermometer Advantages	06
Body Temperature	07
Real Time Clock Setting	08-09
Illustration For Use	10-13
Temperature Taking Guidance	14-15
Memory Mode	16
Selecting A Temperature Scale	17
Care And Cleaning	18-19
Battery Replacement	20
Specifications	21
Troubleshooting	22-23
Calibration	24
Service	25
Warranty	26
Electromagnetic Compatibility Information	27-34

Introduction

The DET-103 thermometer is specifically designed for safe use in the eardrum. The Infrared Ear Thermometer is a device capable of measuring people's body temperature by detecting the intensity of infrared light emitted from the ear canal of humans. It converts the measured heat into a temperature reading displayed on the LCD. When properly used, it will quickly assess your temperature in an accurate manner. The infrared thermometer is intended for the intermittent measurement of human body temperature by people of all ages.



Please read all instructions carefully and thoroughly before using this product.

Warning:

1. This thermometer is intended for home use only. It's not meant to replace a visit to the doctor. Please consult with doctor if you have health concerns.
2. There is no gender or age limitation for using infrared ear thermometer.
3. To avoid inaccurate readings, always attach a new, clean probe cover for each temperature reading.
4. Do not expose the thermometer to temperature extremes (below -25°C/-13°F or over 55°C/131°F) nor excessive humidity (>95%RH).
5. This thermometer must only be used with Seagull Healthcare thermometer probe covers.
6. Keep the battery away from children.
7. Remove batteries from the device when not in operation for a long time.

Product Description

1. Probe Cover
2. Probe
3. TEST Button
4.  Button
5. Battery Cover

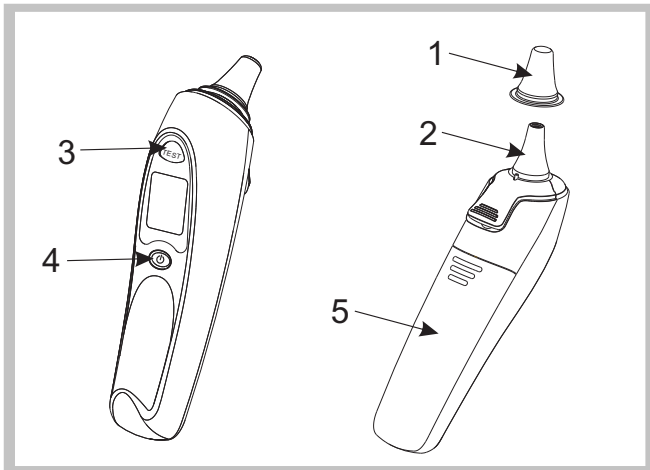

3

LCD Display Introduction

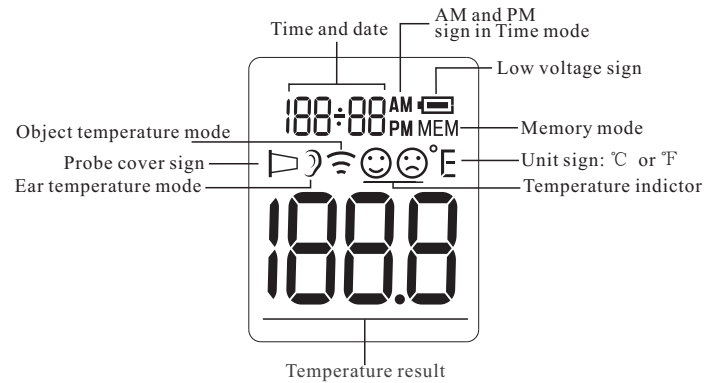

4

Basic Functions

Real Time Clock	The real time clock will be recorded with the memory function and help you to recognize each measurement result → Please see the Real time clock setting section to learn how to setup the time in the first use
Ear Temperature Mode	The thermometer has been designed for practical use. It's not meant to replace a visit to the doctor. Please also remember to compare the measurement result to your regular body temperature → Please see the Illustration For Use section to learn how to measure the body temperature
Probe cover detection and eject function	The thermometer has been designed for use with probe cover Users can press the eject button to remove the probe cover
Object Temperature Mode	The object mode shows the actual, unadjusted surface temperatures, which is different from the body temperature. It can help you to monitor if the object temperature is suitable for the baby or patient, for example the baby's milk → Please see the Illustration For Use section to learn how to measure the object temperature
Alarm	If thermometer detects a body temperature $\geq 37.8^{\circ}\text{C}$ (100.0°F) under ear mode, there will be a long beep sound followed by three short beep sound to warn the user
Memory Mode	There are each 10 sets memories for ear and object measurements Each memory also records the measurement date/time/mode icon
°C/°F Switch	Please see the Selecting A Temperature Scale section to learn how to change between Celsius and Fahrenheit

5

Ear Thermometer Advantages

Infrared Ear Thermometer measures core body temperature, which is the temperature of a body's vital organs. (See Figure 1) Ear temperatures accurately reflect core body temperatures since the eardrum is in the cranial cavity and is not affected by the environment. The eardrum shares blood supply with the hypothalamus (part of the brain.) Therefore, body temperature changes are reflected sooner in the ear than they are in other parts of the body.

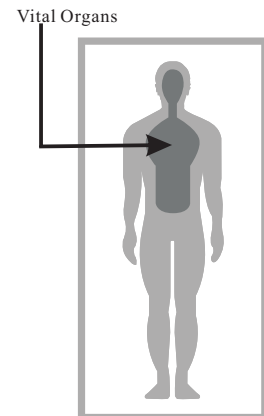

Figure 1

6

Body Temperature

The temperature of a healthy person is affected by various factors: the person's individual metabolism, their age (body temperature is higher in babies and toddlers and decreases with age. Greater temperature fluctuations occur faster and more often in children, e.g. due to growth spurts), their clothing, the ambient temperature, the time of day (body temperature is lower in the morning and increases throughout the day towards evening), the preceding physical and, to a lesser extent, mental activity.

It is suggested that users develop the habit of daily measurement, and use this product to establish a normal temperature range for themselves and their families as a reference for measurement.

7

Real Time Clock Setting

When using thermometer for the first time, please set the parameters of the thermometer. With the thermometer off, press and hold **⏻** *BUTTON* to enter into setting mode for 3 seconds.

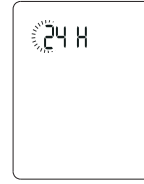

① Set the time format
The device can display the time in either an AM/PM (12-hour) or a 24:00 (24-hour) format. Press and release *TEST BUTTON* to select the format. With the preferred time format on the display, press **⏻** *BUTTON*, and the Hour symbol will flash automatically.



② Set the hour
Press and release the *TEST BUTTON* to advance one hour until the correct hour appears. After the hour is set, press **⏻** *BUTTON*, and the Minute symbol will flash automatically.



③ Set the minute
Press and release the *TEST BUTTON* to advance one minute until the correct minute appears. After the minute is set, press **⏻** *BUTTON*, the Year figure is flashing automatically.

8

Real Time Clock Setting

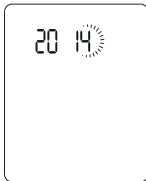

④ Set the year
Press and release the *TEST BUTTON* to advance one year until the correct year appears. After the year is set, press **⏻** *BUTTON*, and the Month symbol will then appear.

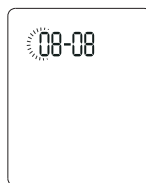

⑤ Set the month
Press and release the *TEST BUTTON* to advance one month until the correct month appears. After the month is set, press **⏻** *BUTTON*, and the Date symbol will now flash.



⑥ Set the date
Press and release the *TEST BUTTON* to advance one day until the correct month appears. After the day is set, press **⏻** *BUTTON* to exit the setting mode.

9

Illustration For Use

► To measure ear temperature:

- To achieve accurate readings, make sure a new, clean probe cover is in place before each readings. Place a new probe cover on the probe firmly; making sure the probe and the inner portion of the probe cover fit snugly.
- Press the **⏻** *BUTTON*, The display is activated to show all segments. After self-checking Figure 2 appears on the display screen with beeps, so you can start a new measurement. If error messages appears, it means the thermometer is not ready for measurement.

Remarks:

- DET-103 must be used with probe cover, if not installed with probe cover, then "CAP" appears on the display. (as shown in Figure 3)
- To avoid the risk of cross contamination, it is recommended that you always measure the ear temperature with probe cover.



Figure 2

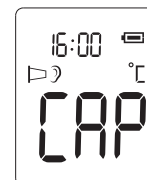

Figure 3

10

Illustration For Use

3. Insert the probe along the ear canal as deep as possible into the ear as depicted in Figure 4. Then press the *TEST BUTTON* once to start the measurement. A long beep will sound approximately 1 second after the *TEST BUTTON* is activated. This signals the end of the process as results are displayed on the LCD screen.
4. The thermometer is ready for testing again once an ear mark displays on the LCD. A waiting period of 20 seconds between testing is recommended to avoid excessive cooling of the skin.
5. The thermometer will shut off automatically after 60 seconds of inactivity. To prolong battery life, press the *ON BUTTON* to turn the unit off.

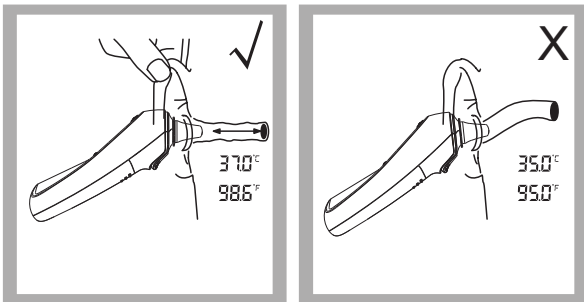

Figure 4

11

Illustration For Use

► To measure object temperature:

1. First eject the probe cover.
2. Aim the thermometer at the center of the object you want to measure with a distance of 1 to 2 cm.
3. Press the *ON BUTTON* to turn on the thermometer, you can take the object temperature after hearing two beep sounds. (see figure 5)

Remarks:

This mode shows the actual, unadjusted surface temperatures, which is different from the body temperature.



Figure 5

► How to change the ear mode and object mode:

You can press and hold *ON BUTTON* and then press and hold the *TEST BUTTON* to switch the mode between ear mode and object mode.

12

Illustration For Use

► After measurement:

1. Power off: Device will automatically shut off if left idle for more than 1 minute to extend battery life.
2. Clean the probe after each use to ensure an accurate reading and avoid cross contamination.
(See the section of Care and Cleaning for details.)

► BackLight:

In Ear mode:

1. The display will be lighted GREEN for 3 seconds with a happy face when the unit is ready for measurement and a measurement is completed with a reading less than 37.3 (99.1).
2. The display will be lighted YELLOW for 3 seconds with a happy face when a measurement is completed with a reading less than 37.8°C(100.0).
3. The display will be lighted RED for 3 seconds with a bad face when a measurement is completed with a reading equal to or higher than 37.8°C(100.0).

In Object mode:

The display will only be lighted GREEN for 3 seconds when the unit is ready for measurement and a measurement is completed

13

Temperature Taking Guidance

1. The right ear reading may differ from the reading taken at the left ear. Therefore, always take the temperature in the same ear.
2. The ear must be free from obstructions or excess earwax buildup to take an accurate reading.
3. External factors may influence ear temperatures such as:
 - lying on one ear or the other
 - their ears covered
 - exposed to very hot or very cold temperatures
 - recently swimming or bathing

In these cases, remove the individual from the situation and wait 20 minutes prior to taking a temperature.
4. For persons wearing hearing aids or ear plugs, remove the device and wait 20 minutes prior to taking a temperature.
5. When using the thermometer on infants under age 1, pull the ear up making sure the sensor faces the eardrum.
(See Figure 6)

14

Temperature Taking Guidance

- When using the thermometer on individuals over the age of 1, pull the ear back making sure the sensor faces the eardrum. (See Figure 7)
- Do not touch the probe window. A cotton swab and rubbing alcohol may be used to clean the sensor window.
- If the thermometer is stored in a significantly different environment than testing location, place it in the testing location for approximately 30 minutes prior to use.



Figure 6



Figure 7

15

Memory Mode

- The Memory Mode can be accessed either in ear mode or object mode:
When the thermometer has been turned on and followed by Figure 2/5 or finished testing, press and hold the **⏻ Button** for three seconds. The letter MEM will appear in the center left corner of the display. (See Figure 8)
- The thermometer will automatically memorize the last 10 temperature readings. Each memory also records the measurement date/time/mode icon. Each time the **⏻ Button** is pressed, the screen displays past readings that correspond with a number 1-10. The number 1 reflects the most recent reading, while the number 10 reveals the oldest reading stored in memory. (See Figure 9)
- In the memory mode, ear mark or scan mark always exist. The user can press the **TEST BUTTON** to take new measurements.

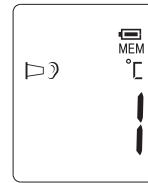

Figure 8

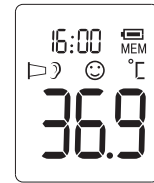

Figure 9

16

Selecting A Temperature Scale

- Temperature readings are available in the Celsius (°C) or Fahrenheit (°F) scale.
- With the unit off, press and hold the **TEST BUTTON** for 3 seconds to enter into unit changing mode.
- Press and release **TEST BUTTON** to select the unit.
- When the preferred unit on the display, press **⏻ BUTTON** to exit the unit changing mode.

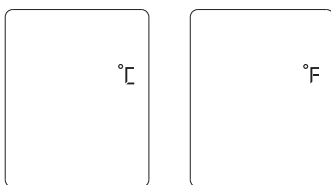

Figure 10

17

Care And Cleaning

- Probe covers are intended for single use only!
Absent, damaged, perforated, or soiled probe covers can lead to inaccurate temperature readings.
- The probe window must be kept clean, dry, and undamaged at all times to ensure accurate readings. The accuracy of temperature readings can be affected by damage to the probe window, or the presence of dirt and ear wax on the probe window.
- Fingerprints, earwax, dust and other soiling compounds reduce transparency of the window and result in lower temperature readings. If the thermometer is accidentally placed in the ear without a probe cover installed, the window must be cleaned immediately.
- The probe window is the most delicate part of the thermometer.
To safely clean the window, gently wipe its surface with a cotton swab slightly moistened with isopropyl alcohol and immediately wipe dry with a clean cotton swab. After cleaning, allow at least 5 minutes drying time before taking temperatures.
Note: Do not use any chemical other than isopropyl alcohol to clean the probe window.
- Use a soft, dry cloth to clean the thermometer display and exterior.
- The thermometer is not waterproof. Do not submerge the unit in water when cleaning.

18

Care And Cleaning

7. Store the thermometer and probe cover in a dry location, free from dust and contamination and away from direct sunlight.
8. Periodic cleaning and disinfection of the device following use to prevent patient cross infection.
-Use a soft cloth slightly moistened with a 75% isopropyl alcohol solution to disinfect the thermometer and probe. Do not use abrasive cleaners.
9. Ensure that children do not use the instrument unsupervised; some parts are small enough to be swallowed.
10. Do not remove or modify the equipment without permission.
11. Strong electromagnetic fields may interfere with the proper operation of the thermometer. The device needs special pre-cautions regarding EMC according to the EMC information.
12. Put the thermometer back to the original packaging after using.
13. It is not intended for use in the oxygen rich environment and presence of flammable anesthetic mixture with air, oxygen or nitrous oxide.

19

Battery Replacement

1. Replace battery when "  " appears in the upper right corner of LCD display. (See Figure 11)
2. Slide battery cover down as shown in Figure 12.
3. Remove battery and install 2 new AAA alkaline batteries as shown in Figure 13 .
4. Slide battery cover back on.



Figure 11

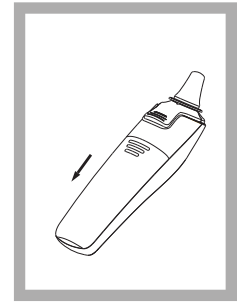

Figure 12

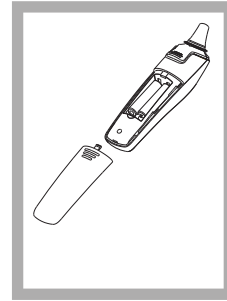

Figure 13







20

Specifications

Measuring range	Ear mode: 32.0°C~43.0°C(89.6°F~109.4°F) Object mode: 0°C~100°C(32°F~212°F)
Measuring site	Ear canal(Ear Mode)
Operation mode	Ear mode(Adjust mode)
Laboratory accuracy	Ear mode: ±0.2°C (0.4°F) during 35.5°C~42.0°C (95.9°F~107.6°F) at 15°C~35°C (59.0°F~95.0°F) operating temperature range ±0.3°C (0.5°F) for other measuring and operating temperature range Object mode: ±4% or ±2°C(4°F) whichever is greater
Display resolution	0.1°C or 0.1°F
Measure time	Approximately one second
Operating temperature range:	Ear/Object mode: 10°C~40°C(50°F~104°F), 15%~85%RH, non-condensing Atmospheric Pressure : 700hPa ~ 1060hPa
Storage and transport temperature range	-25°C~ 55°C (-13°F~131°F), 15%~95%RH, non-condensing Atmospheric Pressure : 700hPa ~ 1060hPa
Clinical accuracy	Clinical bias: 0.08°C (0.14°F) Clinical repeatability: 0.13°C (0.23°F) Limits of agreement:0.73°C (1.31°F)
Shock	withstands drop of 3 feet
Dimension	155 x 38x 47mm
Weight	Approx. 83grams(with batteries)
Battery	DC3V(2×AAA battery)
Battery life	Approx. 6000 readings
Ingress protecting rating	IP22

21

Troubleshooting

Error message	Problem	Solution
	Measurement before thermometer is ready	Take a measurement until  or  appears on the display
	The ambient temperature is not within the range between 10°C and 40°C (50°F~104°F)	Place the thermometer in a room for at least 30 minutes at room temperature between 10°C and 40°C (50°F~104°F)
	The thermometer is placed incorrectly or unsteady	Read Illustration For Use thoroughly and take a new temperature measurement
	The thermometer showing a rapid ambient temperature change	Allow the thermometer to rest in a room for at least 30 minutes at room temperature: between 10°C and 40°C (50°F~104°F)
	The thermometer is not functioning properly	Unload the battery, wait for 1 minute and repower it. If the message reappears, contact the retailer for service

22

Troubleshooting

Error message	Problem	Solution
	In object temperature mode, measurement with probe cover	Remove probe cover in object temperature mode
	In Ear mode: Temperature taken is higher than 43.0 °C(109.4°F) In Object mode: Temperature taken is higher than 100 °C(212°F)	Read Temperature Taking Hints Thoroughly, then check the integrity of the probe cover and take a new temperature measurement
	In Ear mode: Temperature taken is lower than 32.0 °C(89.6°F) In Object mode: Temperature taken is lower than 0 °C(32°F)	Read Temperature Taking Hints thoroughly, then make sure the probe cover and lens filter are clean, then take a new temperature measurement
	The thermometer works properly	Use the thermometer normally
	When battery outline flashes, it indicates that the power is low, but you can continue to measure	The thermometer will take a proper measurement but batteries must be replaced soon
	The thermometer could not work due to low battery	Replace two new alkaline batteries size AAA
	Probe cover was not used when taking ear temperature	Please use probe cover when measuring in ear temperature mode

23

Calibration

The user must always comply with legal requirements for the control of the measurement, functionality, and accuracy of the device which are required by the scope of relevant laws, directives or ordinances where the device is used.



Type BF applied part



Direct Current



Disposal of this product and used batteries should be carried out in accordance with the national regulations for the disposal of electronic products



Consult Accompanying Documents



Batch Code



Storage and Transportation Temperature Limit:
-13°F°C~131°F(-25°C~55°C)

24

Service

The thermometer has a limited two years warranty. Do not attempt to disassemble or repair the thermometer by yourself. Should service be required during the warranty period you must contact the manufacturer. Repackage the thermometer carefully in its original packaging or securely pack to avoid damage during shipping. Include the original sales slip indicating the date of purchase, a note describing the problem, and your return address. Send the thermometer prepaid and insured. The lay operator or lay responsible organization should contact the manufacturer or the manufacturer's representative:

- for assistance, if needed, in setting up, using or maintaining the thermometer; or
- to report unexpected operation or events.



Manufacturer:
JOYTECH HEALTHCARE Co., Ltd.
No.365, Wuzhou Road, Yuhang Economic Development Zone, Hangzhou city,
311100 Zhejiang, China
Telephone: +86-571-81957767
Fax: +86-571-81957750
Importer:
Seagull Aps
Industrivej 1
DK-4200 Slagelse
www.seagull-healthcare.dk



The product is in compliance with the requirements of MDD 93/42/EEC, "0197" is the identification number of notify body;



European Authorized Representative:
Shanghai International Holding Corp. GmbH (Europe)
Eiffestrasse 80, 20537 Hamburg, Germany

25

Warranty

This appliance conforms to the following standards:
EN 12470-5 Clinical thermometers —Part 5:Performance of infrared ear thermometers(with maximum device),
ISO 80601-2-56 Medical electrical equipment —Part 2-56: Particular requirements for basic safety and essential performance of clinical thermometers for body temperature measurement,
IEC 60601-1-11 Medical electrical equipment —Part 1-11: General requirements for basic safety and essential performance –Collateral Standard: Requirements for medical electrical equipment and medical electrical systems used in the home healthcare environment and complies with the requirements of IEC 60601-1-2(EMC) , IEC 60601-1(Safety) standards. And the manufacturer is ISO 13485 certified.

Thermometer is warranted by manufacture to be free from defects in material and workmanship under normal use and service for a period of one year from the date of delivery to the first user who purchases the instrument. This warranty does not cover batteries, damage to the probe window, or damage to the instrument caused by misuse, negligence or accident, and extends to only to the first purchaser of the product. Additionally this warranty becomes void, if the thermometer is operated with anything other than this brand thermometer probe covers.

26

Electromagnetic Compatibility Information

The device satisfies the EMC requirements of the international standard IEC 60601-1-2. The requirements are satisfied under the conditions described in the table below. The device is an electrical medical product and is subject to special precautionary measures with regard to EMC which must be published in the instructions for use. Portable and mobile HF communications equipment can affect the device. Use of the unit in conjunction with non-approved accessories can affect the device negatively and alter the electromagnetic compatibility. The device should not be used directly adjacent to or between other electrical equipment.

27

Electromagnetic Compatibility Information

Table 1

Guidance and manufacturer's declaration – electromagnetic emission		
The device is intended for use in the electromagnetic environment specified below. The customer or the user of the device should assure that it is used in such an environment		
Emissions test	Compliance	Electromagnetic environment – guidance
RF emissions CISPR 11	Group 1	The device uses RF energy only for its internal function. Therefore, its RF emissions are very low and are not likely to cause any interference in nearby electronic equipment
RF emissions CISPR 11	Class B	The device is suitable for use in all establishments, including domestic establishments and those directly connected to the public low-voltage power supply network that supplies buildings used for domestic purposes
Harmonic emissions IEC 61000-3-2	Not applicable	
Voltage fluctuations / flicker emissions IEC 61000-3-3	Not applicable	

28

Electromagnetic Compatibility Information

Table 2

Guidance and manufacturer's declaration – electromagnetic immunity			
The device is intended for use in the electromagnetic environment specified below. The customer or the user of the device should assure that it is used in such an environment			
Immunity test	IEC 60601 test level	Compliance level	Electromagnetic environment - guidance
Electrostatic discharge (ESD) IEC 61000-4-2	± 8 kV contact ±2 kV, ±4 kV, ±8 kV, ±15 kV air	± 8 kV contact ±2 kV, ±4 kV, ±8 kV, ±15 kV air	Floors should be wood, concrete or ceramic tile. If floors are covered with synthetic material, the relative humidity should be at least 30 %
Electrostatic transient / burst IEC 61000-4-4	± 2 kV for power supply lines 100 kHz repetition frequency ± 1 kV for input/output lines	N/A	N/A
Surge IEC 61000-4-5	± 0.5 kV, ± 1 kV differential mode line-line	N/A	N/A
Voltage dips, short interruptions and voltage variations on power supply input lines IEC 61000-4-11	0 % UT (100 % dip in UT) for 0.5 cycle at 0°, 45°, 90°, 135°, 180°, 225°, 270°, and 315° 0 % UT (100 % dip in UT) for 1 cycle at 0° 70 % UT (30 % dip in UT) for 25/30 cycles at 0° 0 % UT (100 % dip in UT) for 250/300 cycle at 0°	N/A	N/A
Power frequency (50/60 Hz) magnetic field IEC 61000-4-8	30 A/m, 50/60Hz	30 A/m, 50/60Hz	Power frequency magnetic fields should be at levels characteristic of a typical location in a typical commercial or hospital environment
NOTE: UT is the a. c. mains voltage prior to application of the test level			

29

Electromagnetic Compatibility Information

Table 3

Guidance and manufacturer's declaration – electromagnetic immunity			
The device is intended for use in the electromagnetic environment specified below. The customer or the user of the device should assure that it is used in such an environment			
Immunity test	IEC 60601 test level	Compliance level	Electromagnetic environment - guidance
Conducted RF IEC 61000-4-6	3 Vrms 150 kHz to 80 MHz 6 Vrms 150 kHz to 80 MHz outside ISM bands	N/A	Portable and mobile RF communications equipment should be used no closer to any part of the device, including cables, than the recommended separation distance calculated from the equation applicable to the frequency of the transmitter Recommended separation distance $d = \left[\frac{3.5}{V_1} \right] \sqrt{P}$
Radiated RF IEC 61000-4-3	10 V/m 80 MHz to 2.7 GHz	10 V/m	$d = \left[\frac{3.5}{E_1} \right] \sqrt{P} \quad 80\text{MHz to } 800\text{MHz}$ $d = \left[\frac{7}{E_1} \right] \sqrt{P} \quad 800\text{MHz to } 2.7\text{GHz}$ where P is the maximum output power rating of the transmitter in watts (W) according to the transmitter manufacturer and d is the recommended separation distance in metres(m). Field strengths from fixed RF transmitters, as determined by an electromagnetic site survey, ^a should be less than the compliance level in each frequency range ^b Interference may occur in the vicinity of equipment marked with the following symbol: 

30

Electromagnetic Compatibility Information

Table 3 continued

NOTE 1 At 80 MHz and 800 MHz, the higher frequency range applies. NOTE 2 These guidelines may not apply in all situations. Electromagnetic propagation is affected by absorption and reflection from structures, objects and people

a The ISM (industrial, scientific and medical) bands between 0,15 MHz and 80 MHz are 6,765 MHz to 6,795 MHz; 13,553 MHz to 13,567 MHz; 26,957 MHz to 27,283 MHz; and 40,66 MHz to 40,70 MHz. The amateur radio bands between 0,15 MHz and 80 MHz are 1,8 MHz to 2,0 MHz; 3,5 MHz to 4,0 MHz; 5,3 MHz to 5,4 MHz; 7 MHz to 7,3 MHz; 10,1 MHz to 10,15 MHz; 14 MHz to 14,2 MHz; 18,07 MHz to 18,17 MHz; 21,0 MHz to 21,4 MHz; 24,89 MHz to 24,99 MHz; 28,0 MHz to 29,7 MHz and 50,0 MHz to 54,0 MHz

b The compliance levels in the ISM frequency bands between 150 kHz and 80 MHz and in the frequency range 80 MHz to 2,7 GHz are intended to decrease the likelihood that mobile/portable communications equipment could cause interference if it is inadvertently brought into patient areas. For this reason, an additional factor of 10/3 has been incorporated into the formulae used in calculating the recommended separation distance for transmitters in these frequency ranges

c Field strengths from fixed transmitters, such as base stations for radio (cellular/cordless) telephones and land mobile radios, amateur radio, AM and FM radio broadcast and TV broadcast cannot be predicted theoretically with accuracy. To assess the electromagnetic environment due to fixed RF transmitters, an electromagnetic site survey should be considered. If the measured field strength in the location in which the device is used exceeds the applicable RF compliance level above, the device should be observed to verify normal operation. If abnormal performance is observed, additional measures may be necessary, such as re-orienting or relocating the device

d Over the frequency range 150 kHz to 80 MHz, field strengths should be less than 3 V/m

Electromagnetic Compatibility Information

Table 4

Recommended separation distances between portable and mobile RF communications equipment and the device

The device is intended for use in an electromagnetic environment in which radiated RF disturbances are controlled. The customer or the user of the device can help prevent electromagnetic interference by maintaining a minimum distance between portable and mobile RF communications equipment (transmitters) and the device as recommended below, according to the maximum output power of the communications equipment

Rated maximum output of transmitter W	Separation distance according to frequency of transmitter m		
	150 kHz to 80 MHz $d = \left[\frac{3.5}{V_1}\right]\sqrt{P}$	80 MHz to 800 MHz $d = \left[\frac{3.5}{E_1}\right]\sqrt{P}$	800 MHz to 2.7 GHz $d = \left[\frac{7}{E_1}\right]\sqrt{P}$
0.01	0.12	0.04	0.07
0.1	0.37	0.12	0.23
1	1.17	0.35	0.7
10	3.7	1.11	2.22
100	11.7	3.5	7.0

For transmitters rated at a maximum output power not listed above the recommended separation distance d in metres (m) can be estimated using the equation applicable to the frequency of the transmitter, where P is the maximum output power rating of the transmitter in watts (W) according to the transmitter manufacturer

NOTE 1 At 80 MHz and 800 MHz, the separation distance for the higher frequency range applies

NOTE 2 These guidelines may not apply in all situations. Electromagnetic propagation is affected by absorption and reflection from structures, objects and people

Electromagnetic Compatibility Information

Table 5

Recommended separation distances between RF wireless communications equipment

The device is intended for use in an electromagnetic environment in which radiated RF disturbances are controlled. The customer or the user of the device can help prevent electromagnetic interference by maintaining a minimum distance between RF wireless communications equipment and the device as recommended below, according to the maximum output power of the communications equipment

Frequency MHz	Maximum Power W	Distance	IEC 60601 Test Level	Compliance Level	Electromagnetic Environment - Guidance
385	1.8	0.3	27	27	RF wireless communications equipment should be used no closer to any part of the device, including cables, than the recommended separation distance calculated from the equation applicable to the frequency of the transmitter Recommended separation distance $E = \frac{6}{d} \sqrt{P}$ Where P is the maximum output power rating of the transmitter in watts (W) according to the transmitter manufacturer and d is the recommended separation distance in meters (m). Field strengths from fixed RF transmitter, as determined by an electromagnetic site survey, should be less than the compliance level in each frequency range. Interference may occur in the vicinity of equipment marked with the following symbol: 
450	2	0.3	28	28	
710	0.2	0.3	9	9	
745					
780					
810					
870	2	0.3	28	28	
930					
1720					
1845	2	0.3	28	28	
1970					
2450	2	0.3	28	28	
5240					
5500					
5785					

Note 1: These guidelines may not apply in all situations. Electromagnetic propagation is affected by absorption and reflection from structures, objects and people

Electromagnetic Compatibility Information

WARNINGS!

- This device should not be used in the vicinity or on the top of other electronic equipment such as cell phone, transceiver or radio control products. If you have to do so, the device should be observed to verify normal operation.
- The use of accessories and power cord other than those specified, with the exception of cables sold by the manufacturer of the equipment or system as replacement parts for internal components, may result in increased emissions or decreased immunity of the equipment or system.